

MPoC and Mobile Updates



Andrew Jamieson

Vice President, Standards



A Brief History (of Face to Face Payments)

- POIs started out as simple PIN Entry Devices
- New payment types & engagement models have driven change

Simple PED

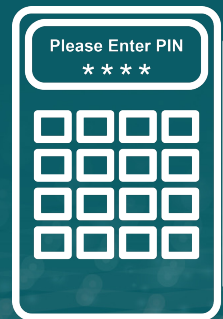

A Brief History (of Face to Face Payments)

- POIs started out as simple PIN Entry Devices
- New payment types & engagement models have driven change

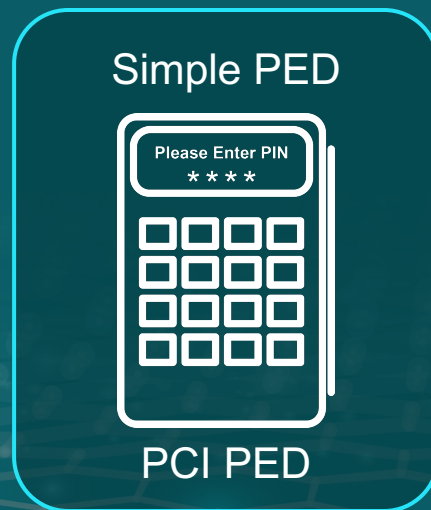

A Brief History (of Face to Face Payments)

- POIs started out as simple PIN Entry Devices
- New payment types & engagement models have driven change

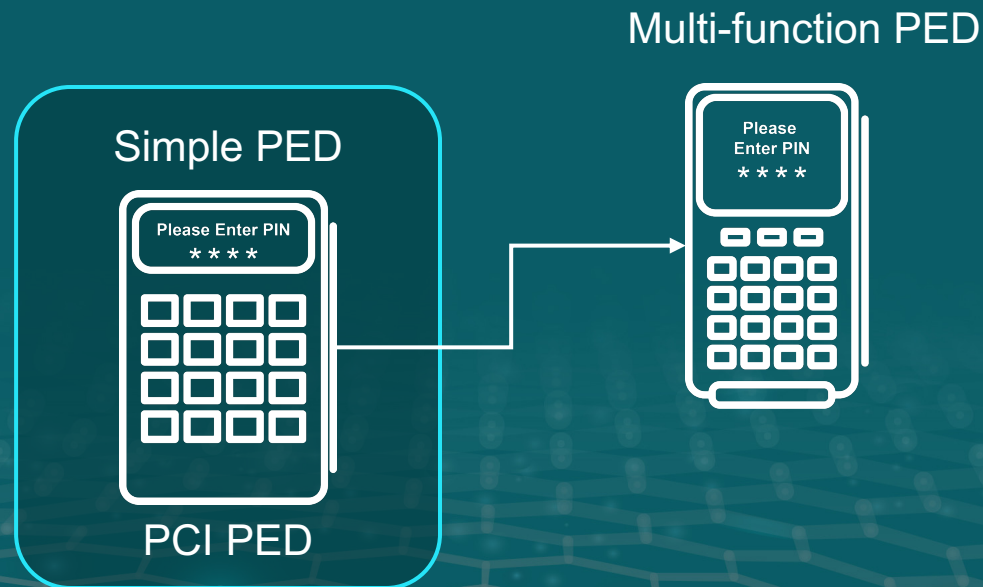

A Brief History (of Face to Face Payments)

- POIs started out as simple PIN Entry Devices
- New payment types & engagement models have driven change

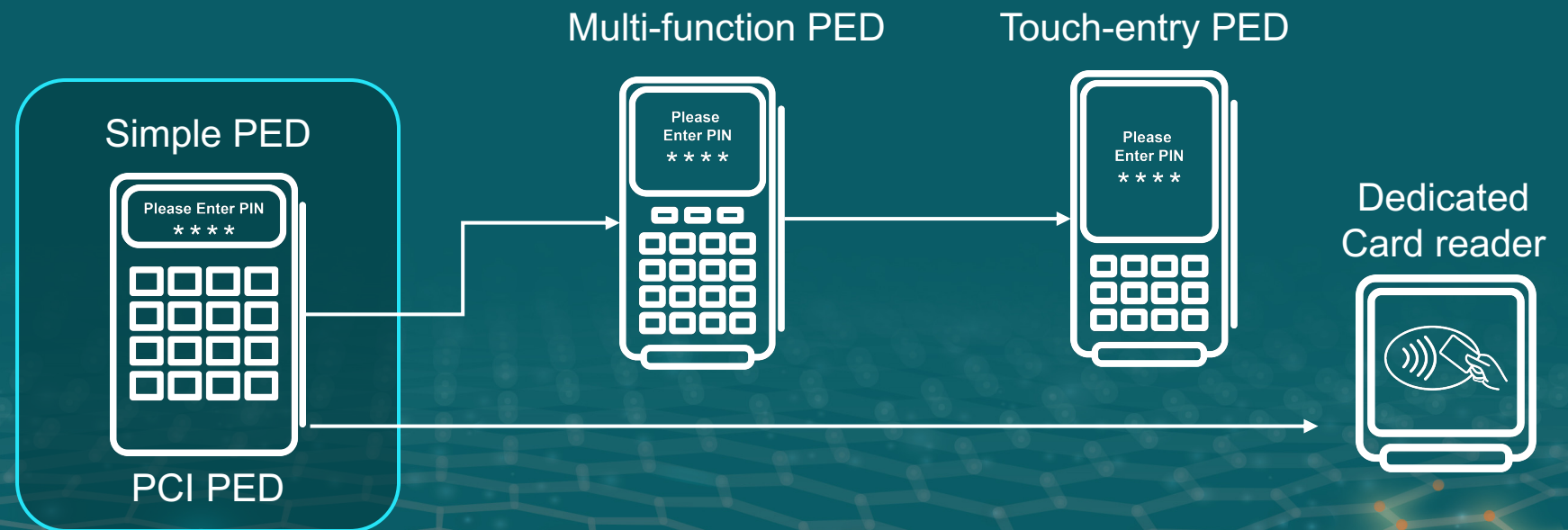

A Brief History (of Face to Face Payments)

- POIs started out as simple PIN Entry Devices
- New payment types & engagement models have driven change

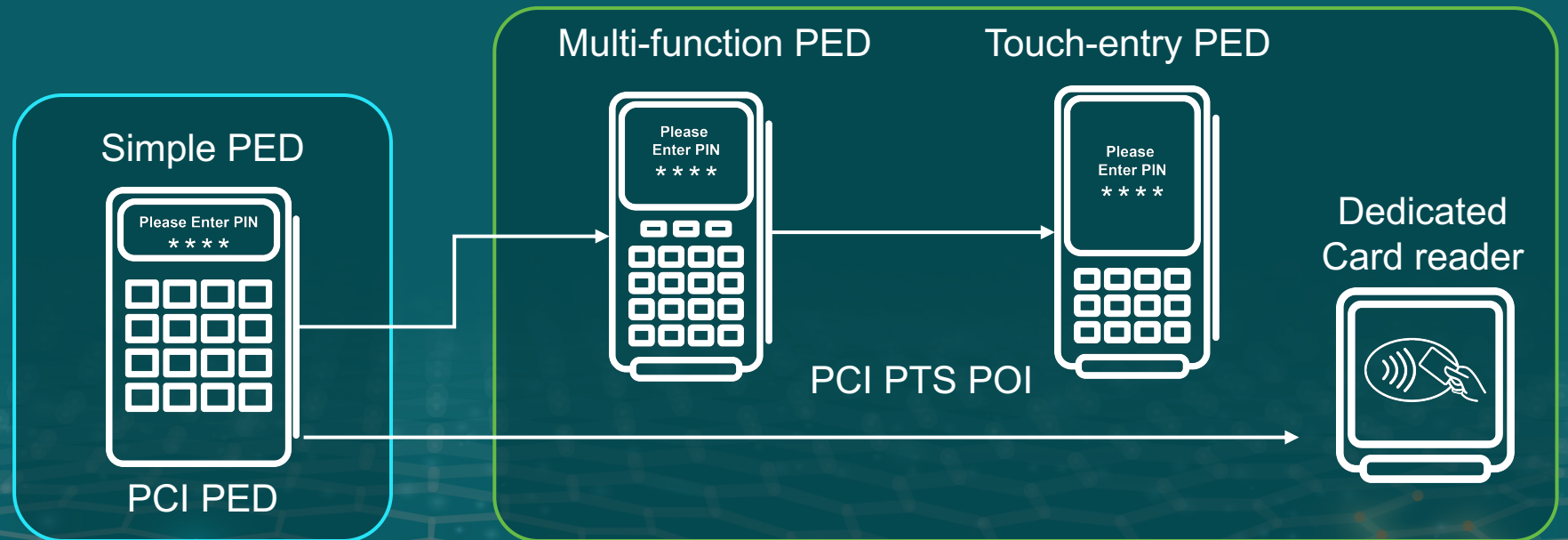

A Brief History (of Face to Face Payments)

- POIs started out as simple PIN Entry Devices
- New payment types & engagement models have driven change

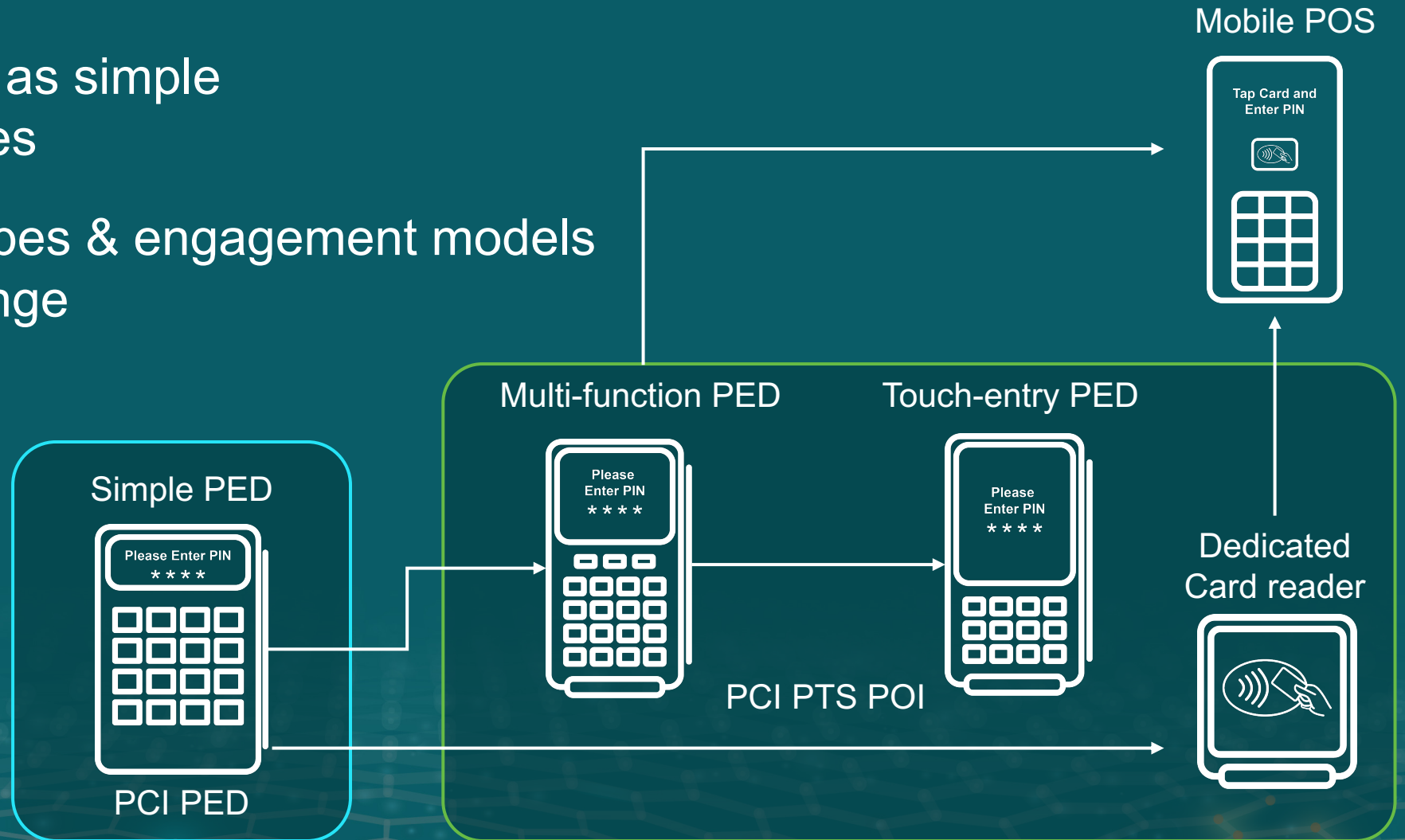

A Brief History (of Face to Face Payments)

- POIs started out as simple PIN Entry Devices
- New payment types & engagement models have driven change

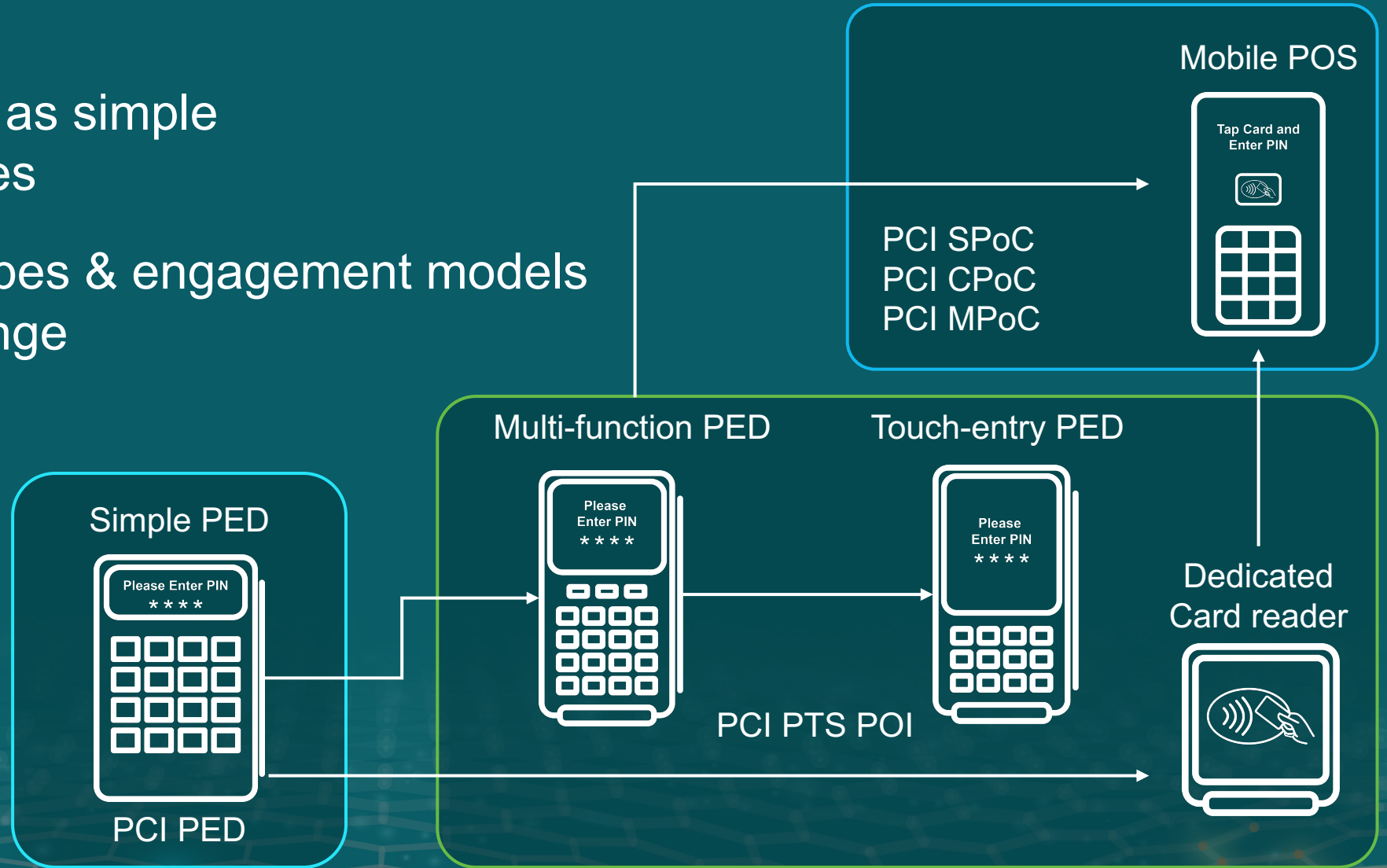

PCI MPoC

PCI MPoC v1.0.1 Security and Test Requirements February 2023

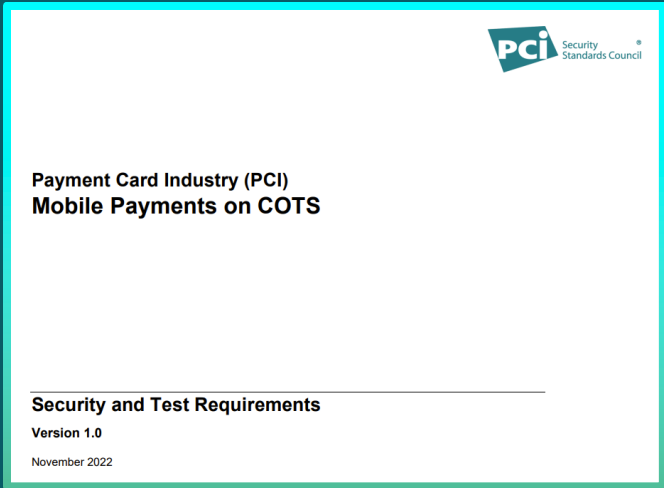

PCI MPoC v1.0
Security and Test Requirements
November 2022

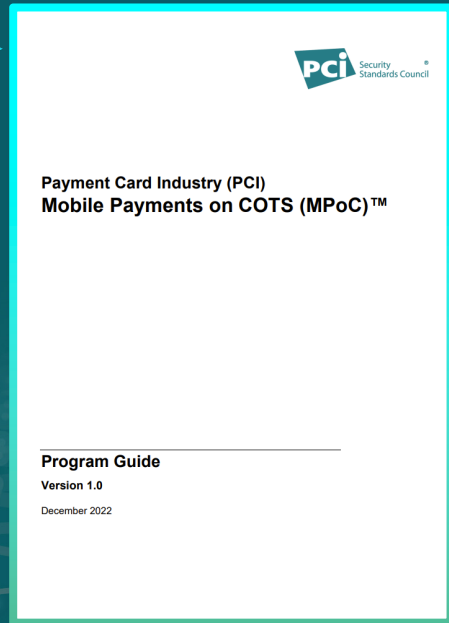
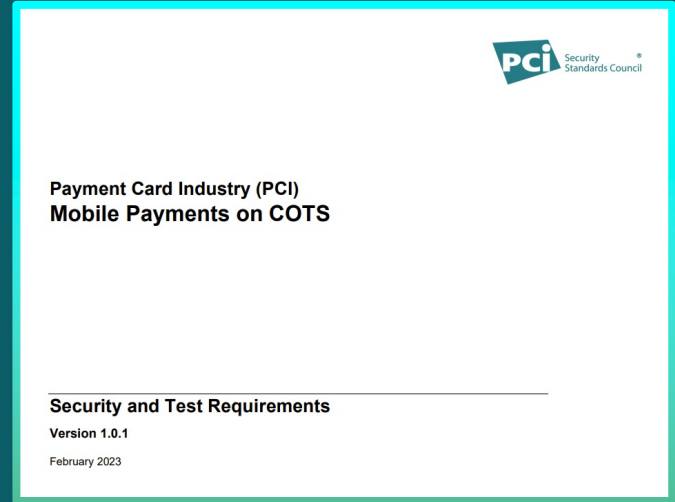

PCI MPoC v1.0
Program Guide
November 2022

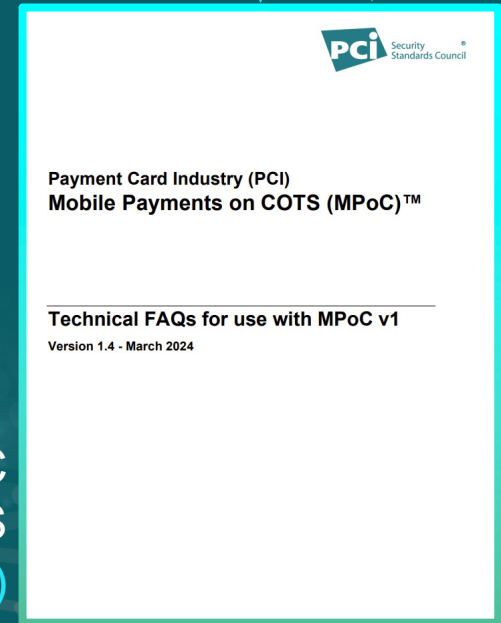

PCI MPoC
Tech FAQs
(as required)

MPoC v1.0.1 Feedback

- Laboratory testing of MPoC Apps is too burdensome
- Increased support for different types of POI devices is required
- The MPoC Product types supported limit potential deployments
- Some requirements are unnecessary
- Some key management requirements are too strict
- The definition of COTS is too restrictive ...

Meetings Schedule

Schedule for meetings:

MTF: 

Wed May 29th 12-1pm EST

Wed June 26th 12-1pm EST

Wed July 24th 12-1pm EST

TGG: 

Tue May 21st 12-1pm EST



Tue June 18th 12-1pm EST



Tue July 16th 12-1pm EST



Last meetings on 19th and/or 26th August
(These are the go/no-go meetings)

Week 10th June on-site meetings in Barcelona
(MWG  cancelled for that week)

MAY						
Su	M	Tu	W	Th	F	Sa
			1	2	3	4
5	6	7	8	9	10	11
12	13	14	15	16	17	18
19	20		22	23	24	25
26	27	28		30	31	

JUNE						
Su	M	Tu	W	Th	F	Sa
						1
2	3	4	5	6	7	8
9	10	11	12	13	14	15
16	17		19	20	21	22
23	24	25		27	28	29
30						

JULY						
Su	M	Tu	W	Th	F	Sa
	1	2	3	4	5	6
7	8	9	10	11	12	13
14	15		17	18	19	20
21	22	23		25	26	27
28	29	30	31			

AUGUST						
Su	M	Tu	W	Th	F	Sa
				1	2	3
4	5		7	8	9	10
11	12	13	14	15	16	17
18		20	21	22	23	24
25	26	27	28	29	30	31

MPoC v1.1 RFC

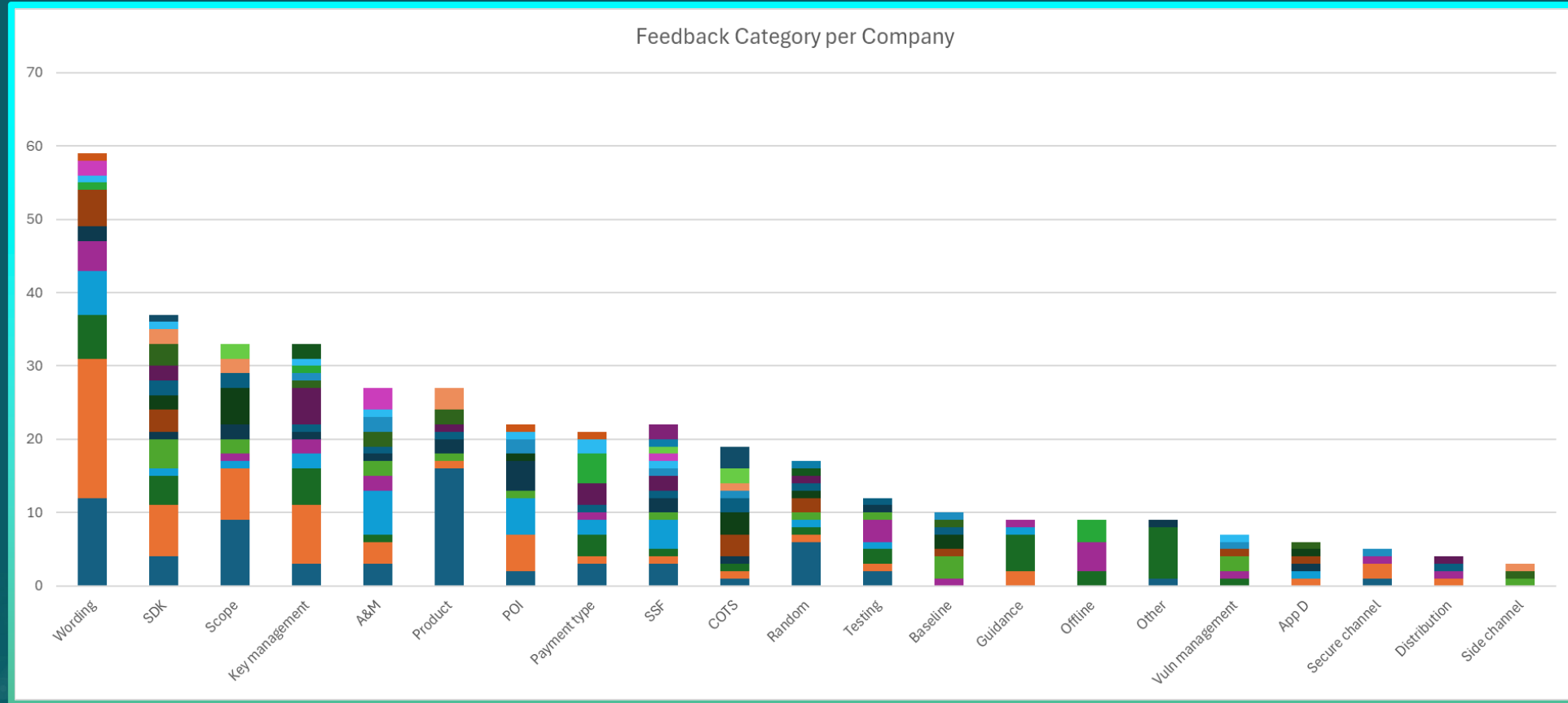

MPoC v1.1 RFC Disposition

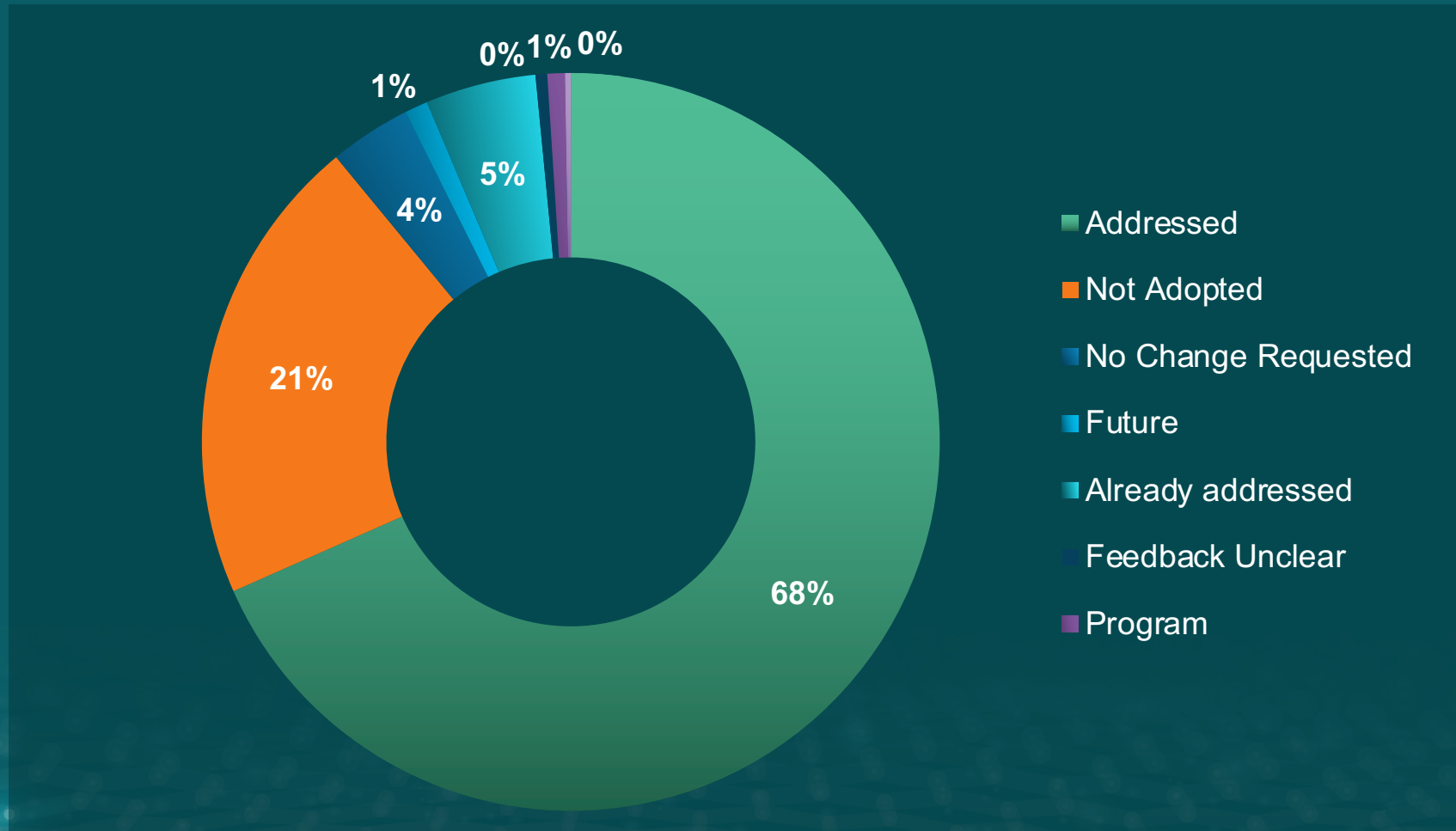

MPoC v1.1 – Change Highlights

- MPoC Apps integrating an Isolating SDK can be validated directly by the vendor the MPoC SDK they are integrating
- MPoC A&M Service → MPoC Service (A&M), or MPoC Service (A&M and Payment)
- Allow for one MPoC SDK to integrate another MPoC SDK
- Allow for MPoC SDK to have integrating COTS-based software manage payment secure channel
- Removal of Secure Software validation requirement for backend A&M software
- Integration of existing MPoC v1.0.1 Tech FAQs, add to guidance and other changes throughout
- Updated Definition of COTS

MPoC v1.0.1 vs v1.1

MPoC v1.0.1

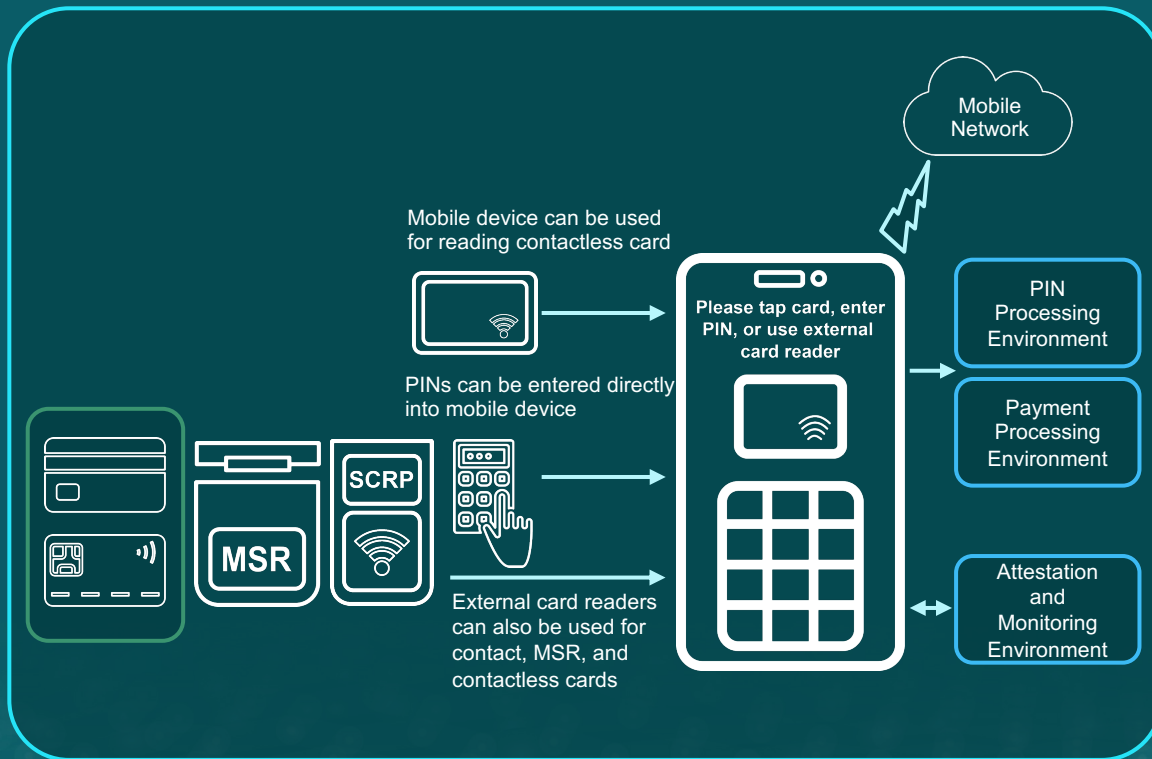

MPoC v1.1

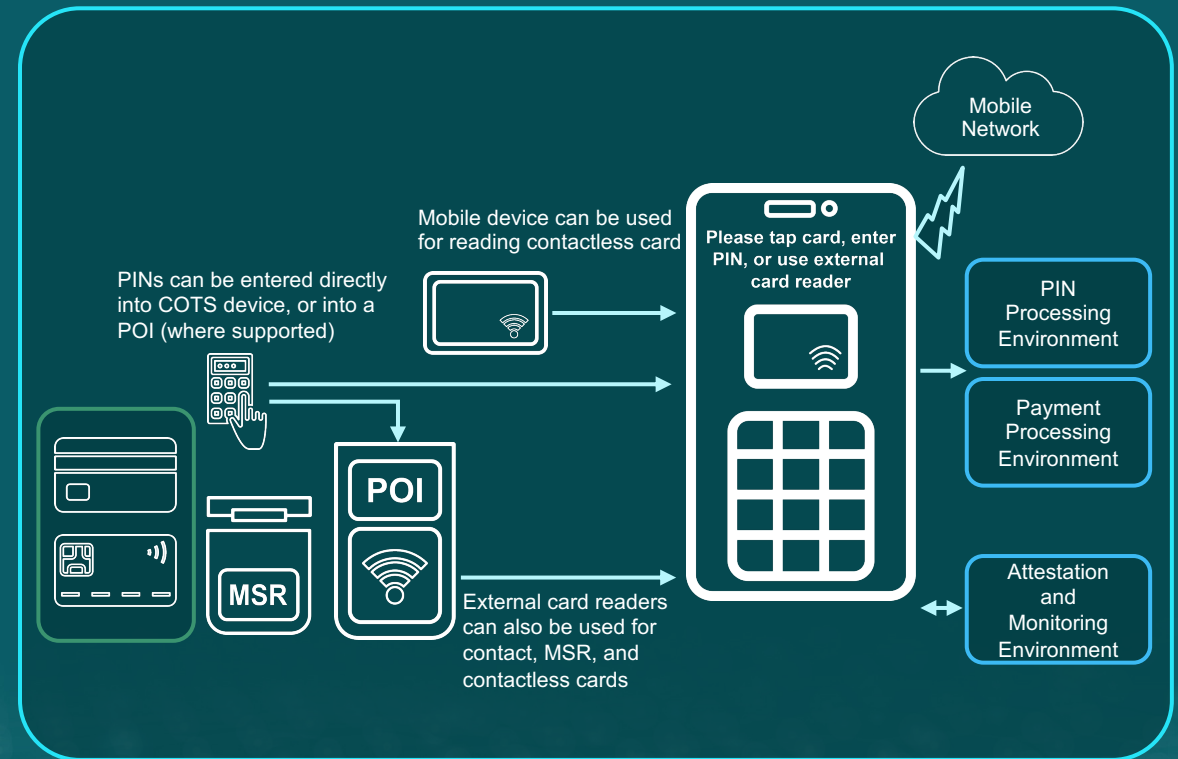

MPoC v1.0.1 Product Deployment Scenarios



COTS Software



A&M Software



Vulnerability Management



A&M Service

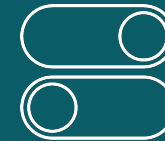

Payment Switch



Acquirers



Key Management



MPoC Apps

MPoC Solution

MPoC v1.0.1 Product Deployment Scenarios

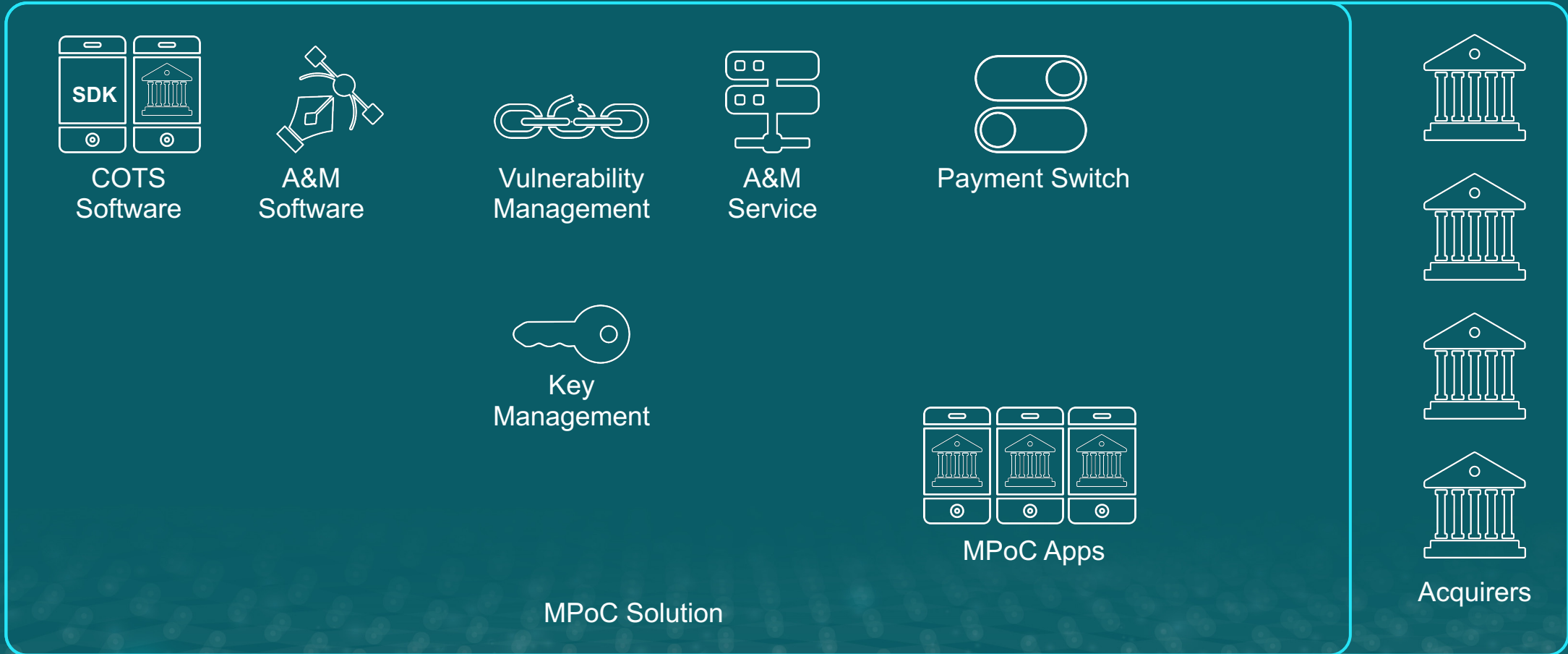

MPoC v1.0.1 Product Deployment Scenarios

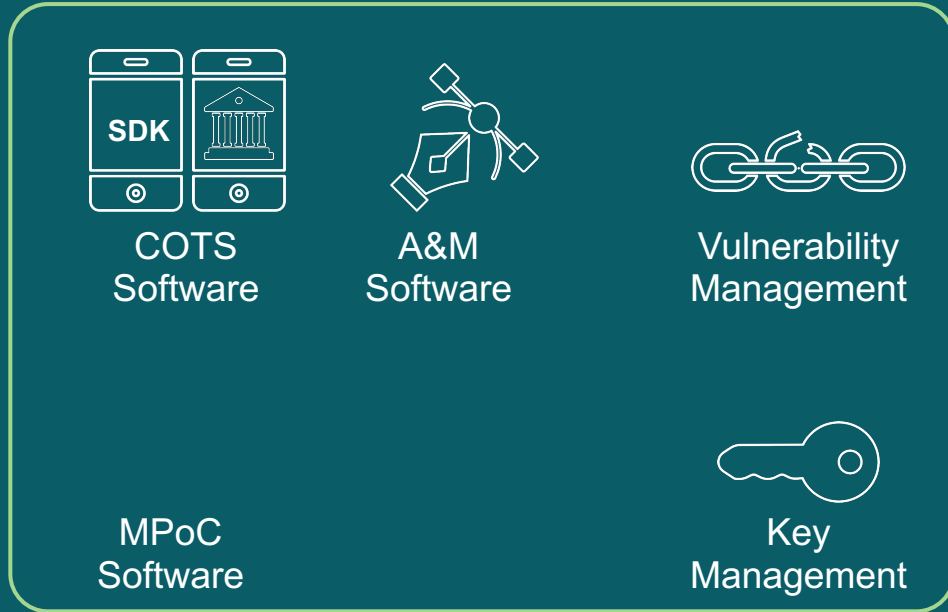

Acquirers

MPoC v1.0.1 Product Deployment Scenarios

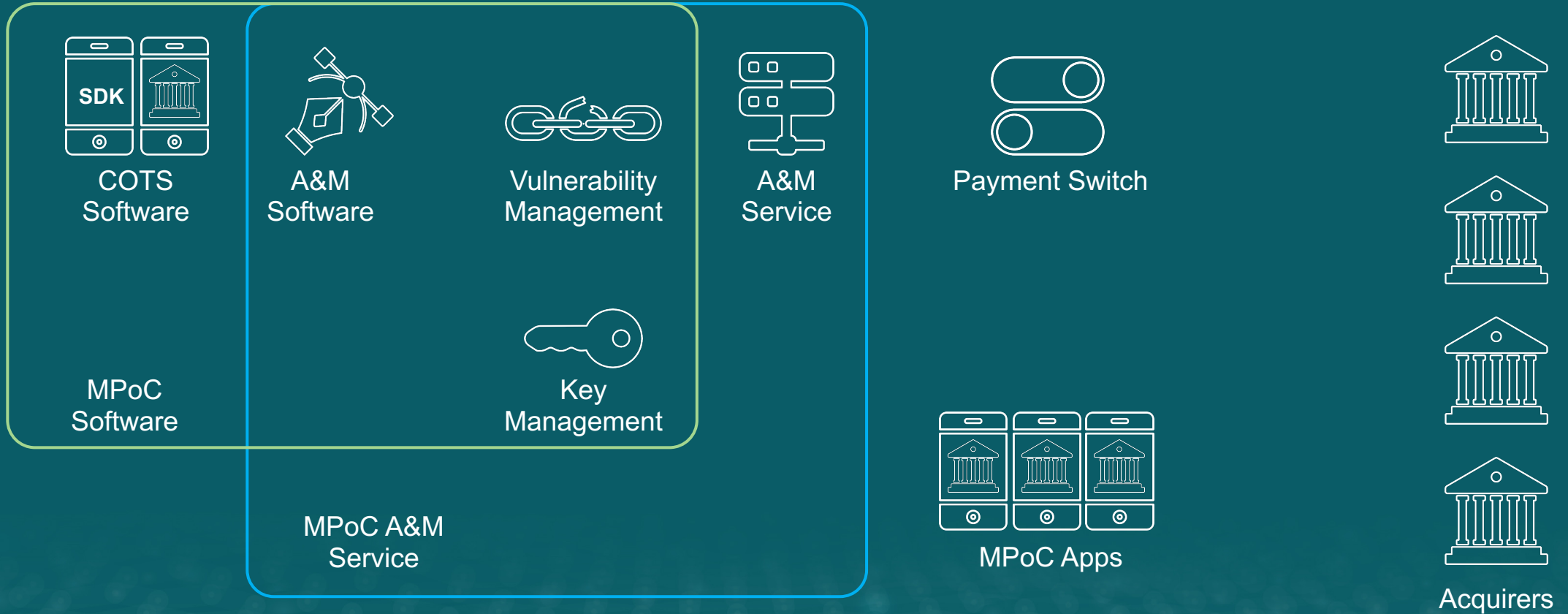

MPoC v1.0.1 Product Deployment Scenarios

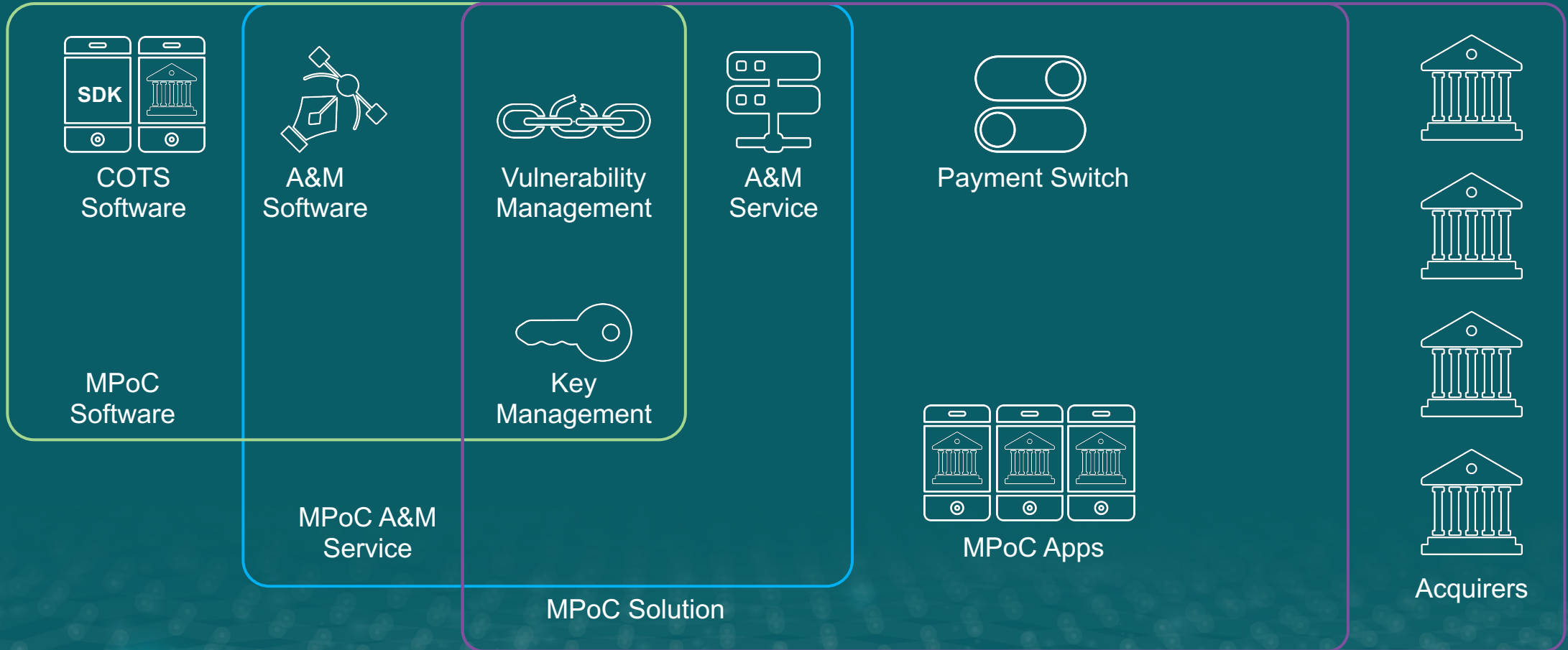

MPoC v1.1 Product Deployment Scenarios

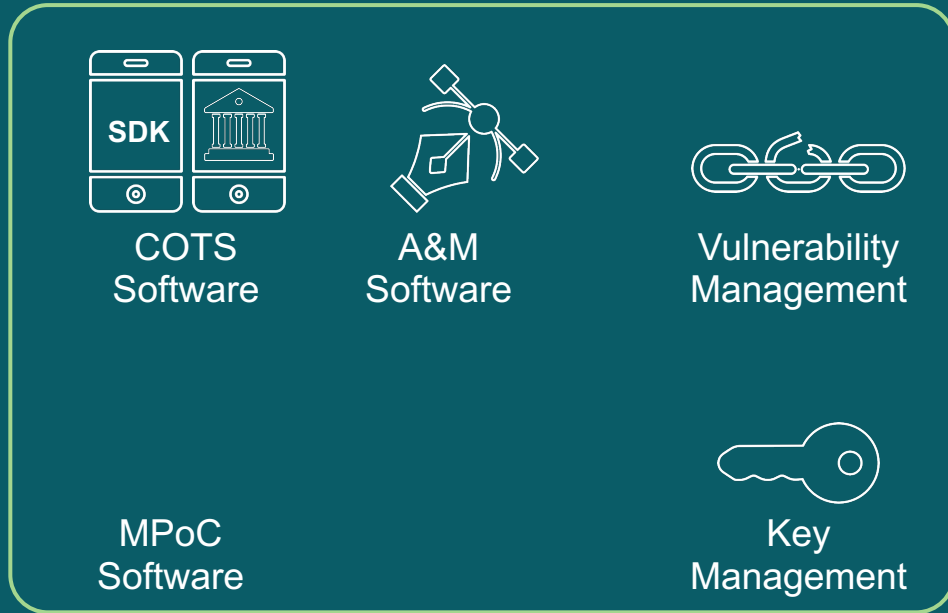

Acquirers

MPoC v1.1 Product Deployment Scenarios

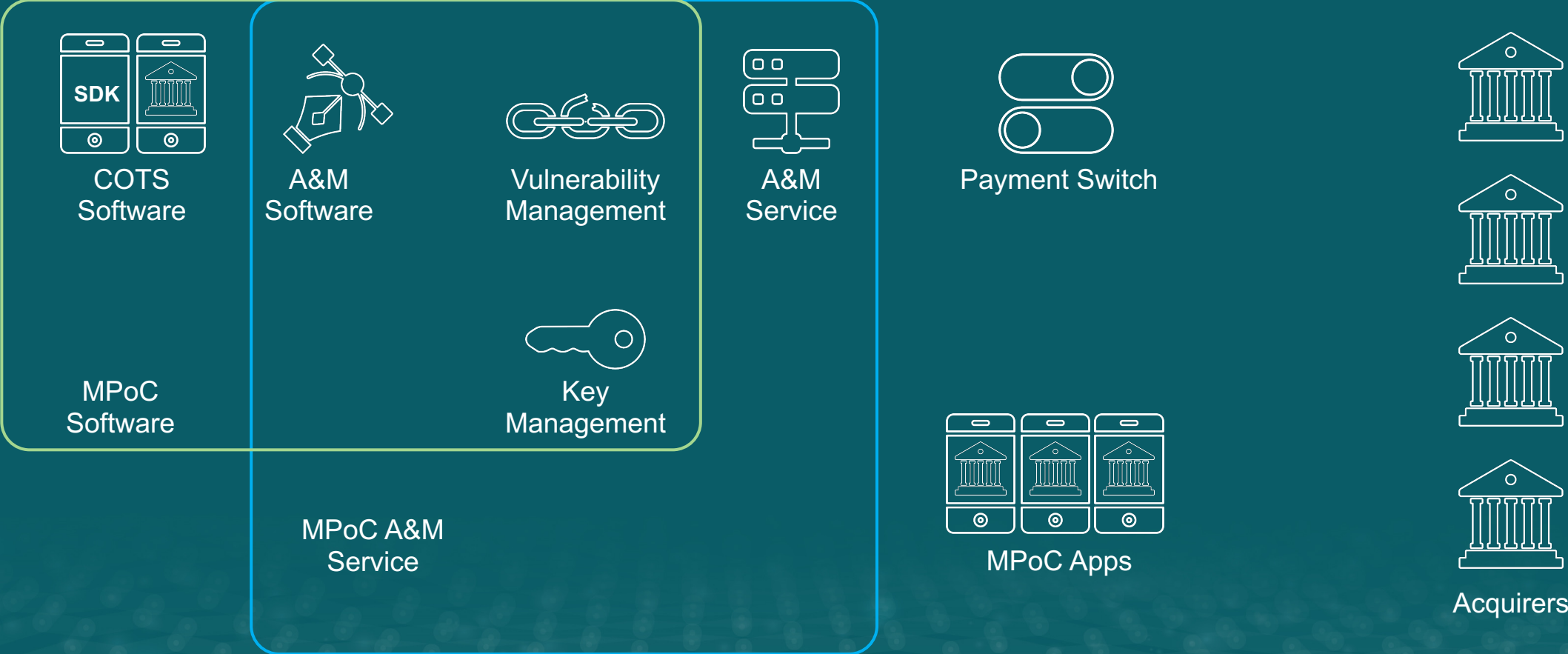

MPoC v1.1 Product Deployment Scenarios

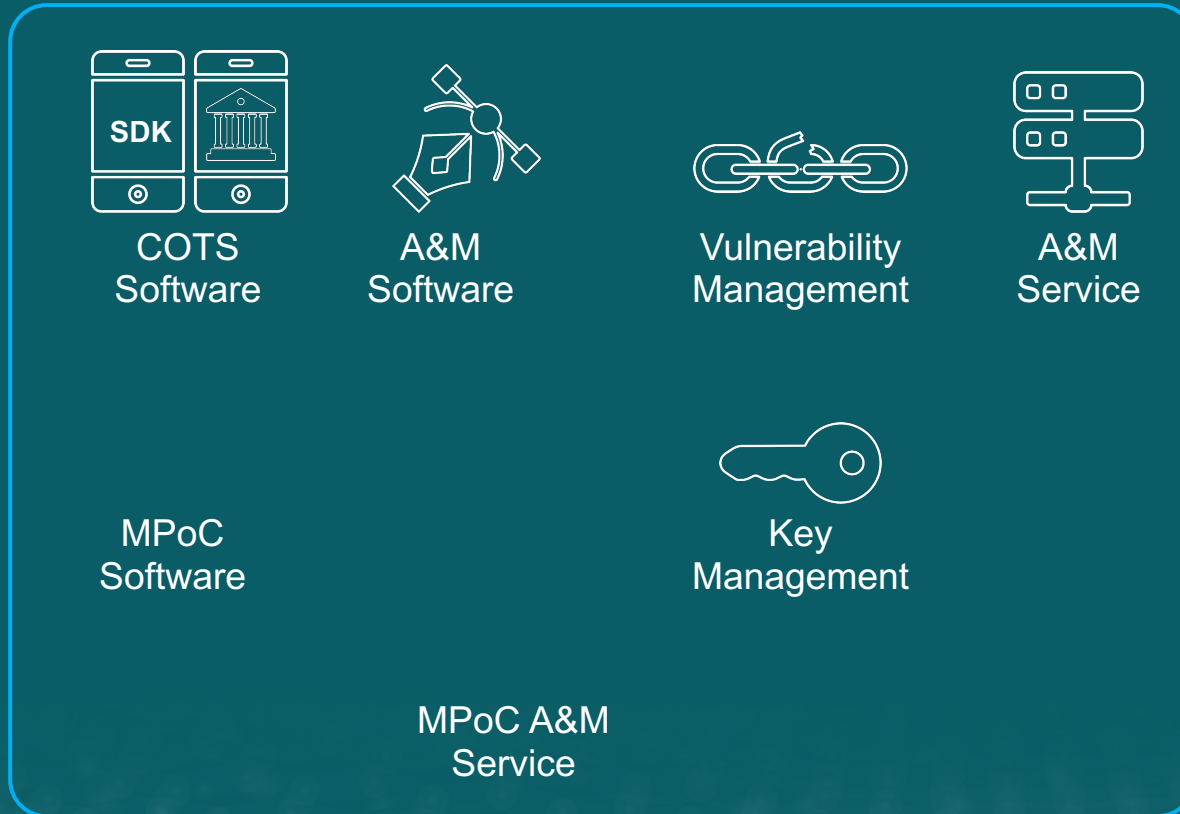

Acquirers

MPoC v1.1 Product Deployment Scenarios

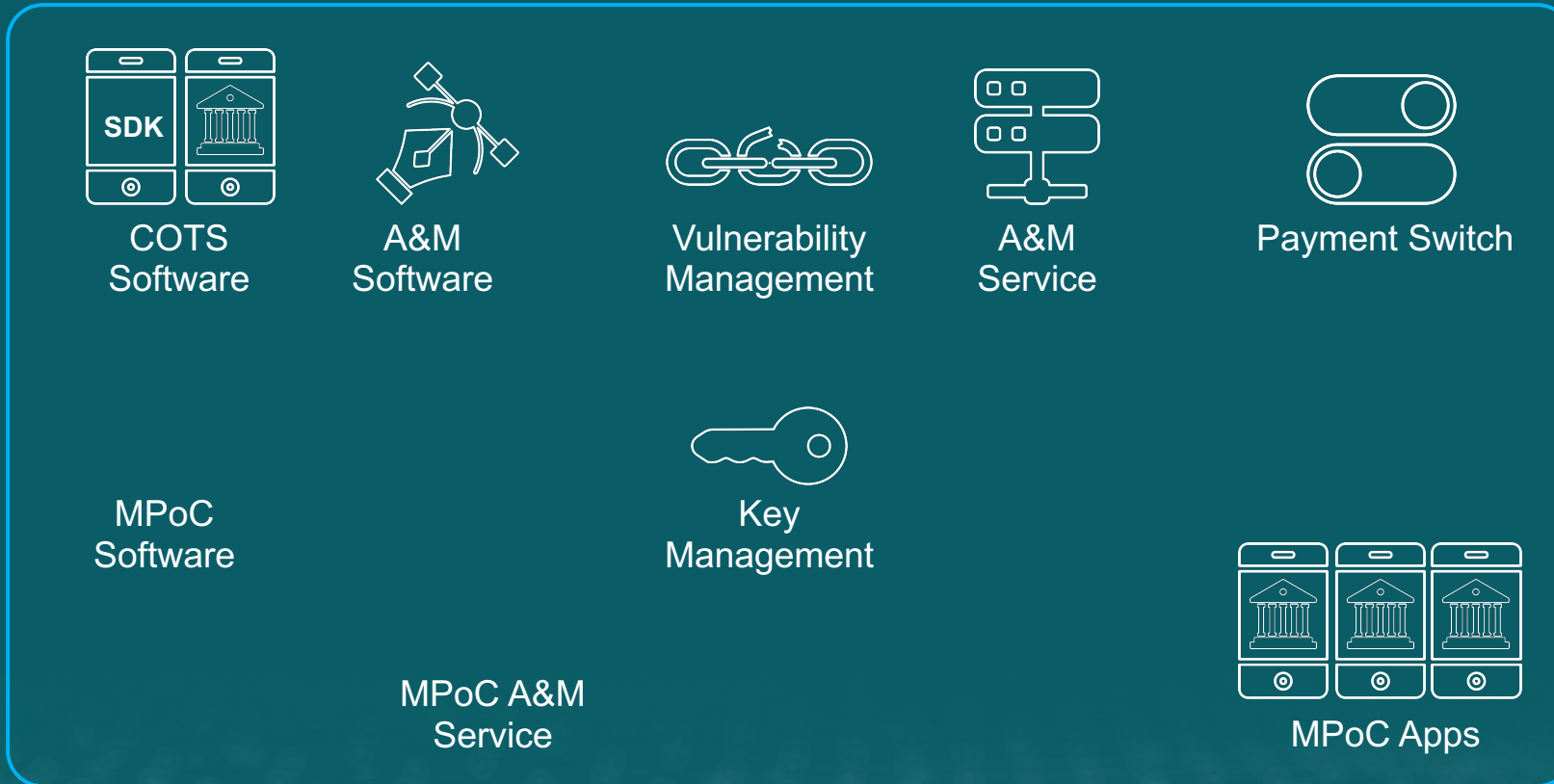

Acquirers

MPoC v1.1 Product Deployment Scenarios

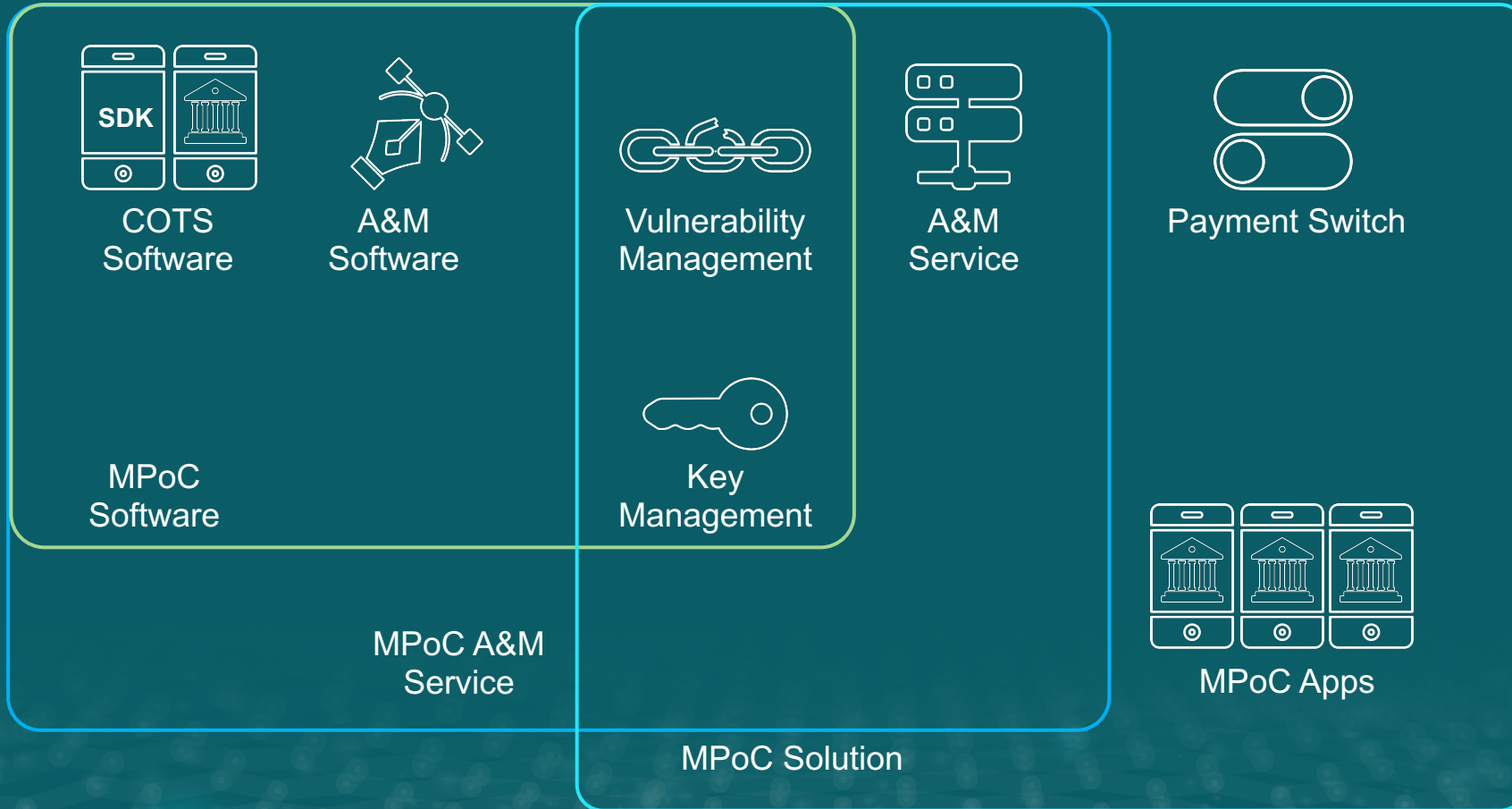

MPoC v1.1 Product Deployment Scenarios

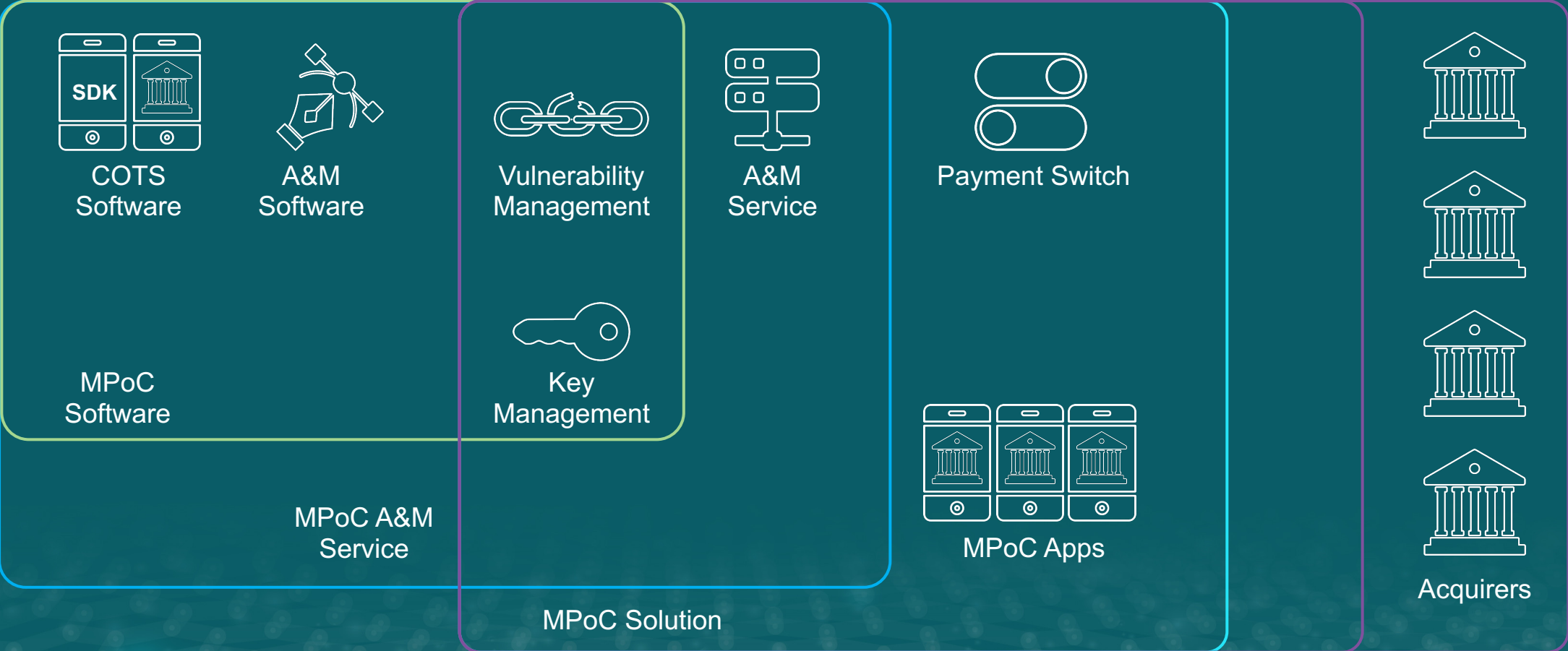

What About MPoC SDKs?

MPoC SDK and Acceptance Options

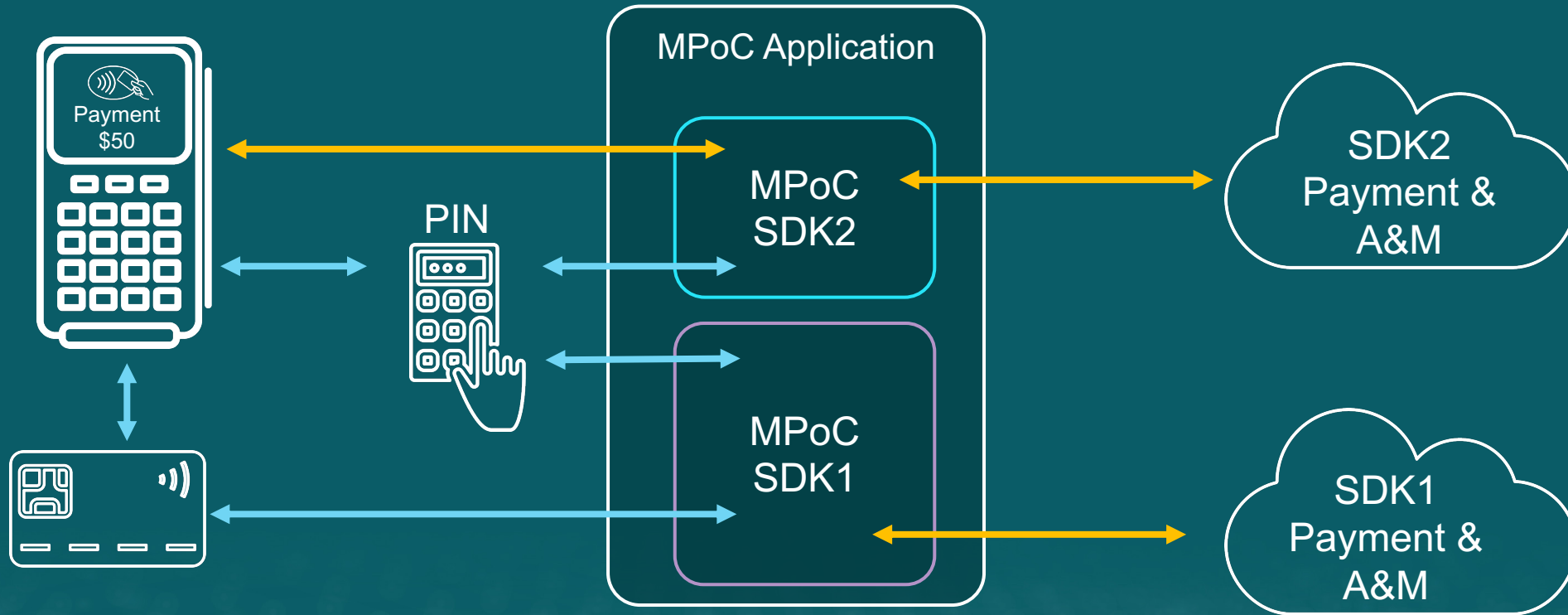

MPoC SDK Options

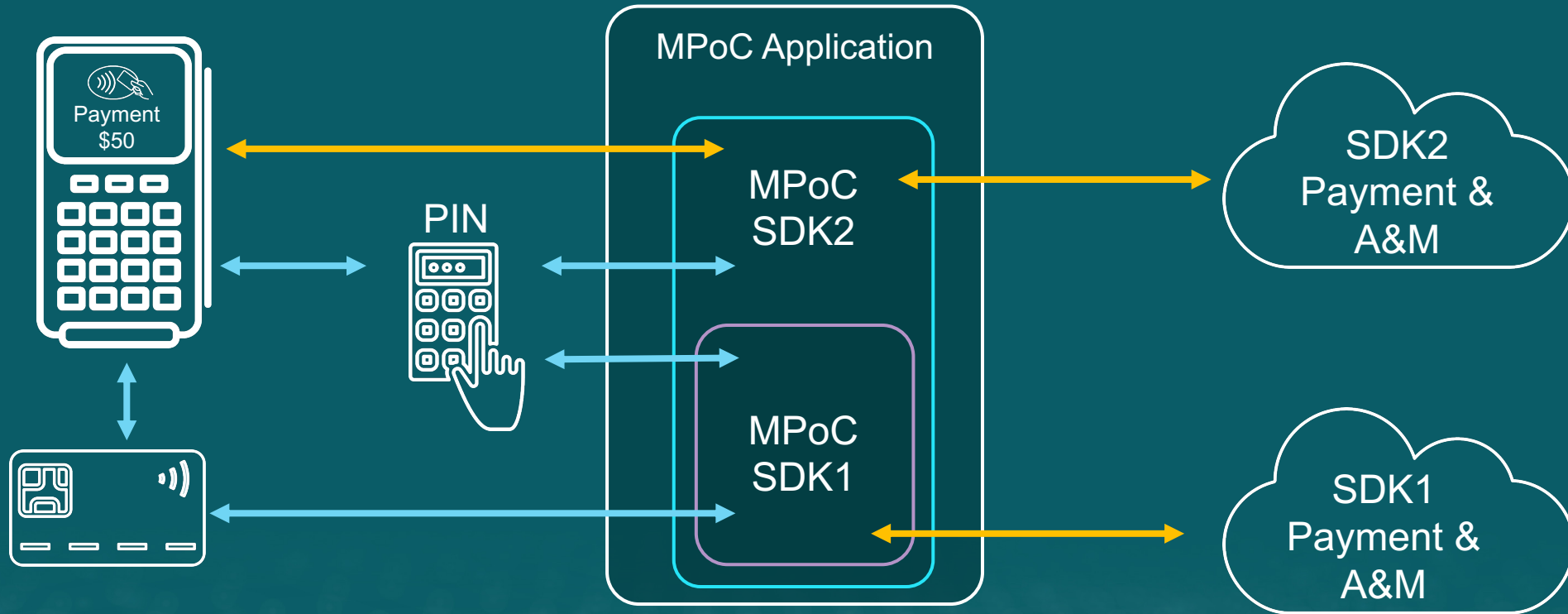

MPoC SDK Options

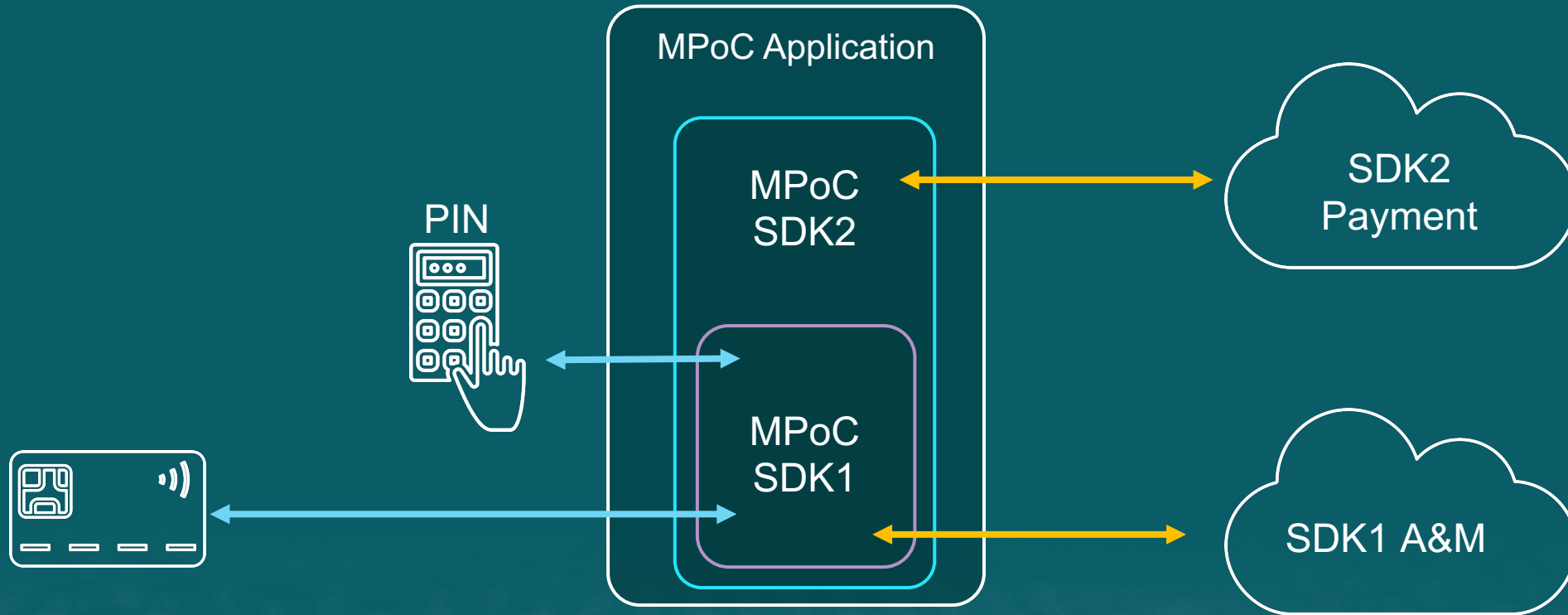

MPoC SDK Options

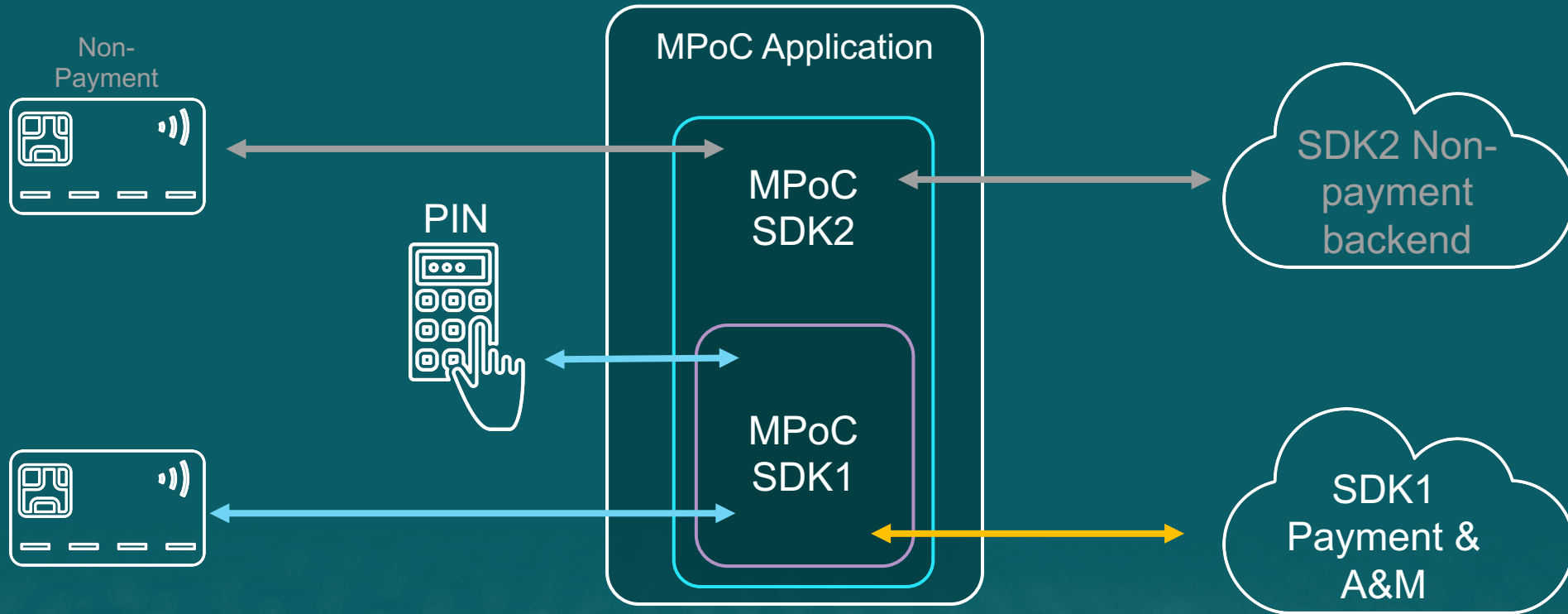

MPoC SDKs

Validated
through
lab testing

Example (1): Two separate MPoC SDKs - currently supported in MPoC v1.0.1

Example (2): MPoC SDK2 adds support for new payment channels

Figure 4: Example Implementations using Multiple MPoC SDKs

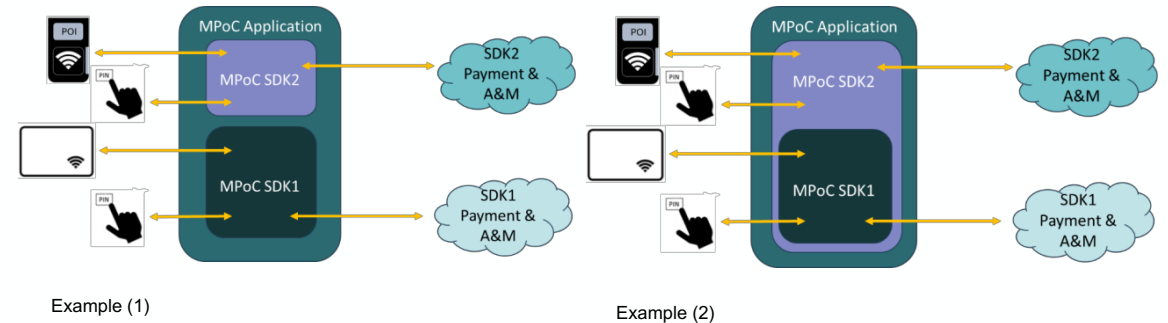

MPoC SDKs

Validated
through
vendor
testing*

Example (4): MPoC SDK2 adds functions not relevant to MPoC, such as transport ticketing functions or rebranding

Figure 4: Example Implementations using Multiple MPoC SDKs

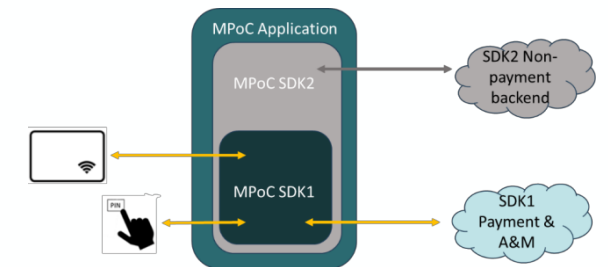

MPoC SDKs

Depends
on change

Example (3): MPoC SDK2 adds potentially MPoC-relevant functions, such as message formatting or secure channel(s)

Figure 4: Example Implementations using Multiple MPoC SDKs

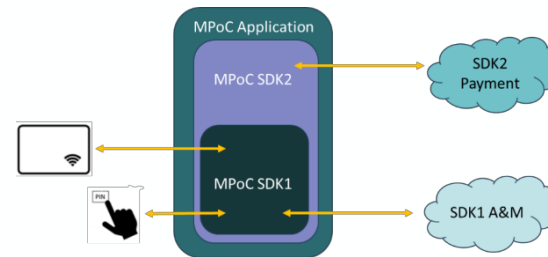

Example (3)

MPoC SDKs

Depends on change

Example (3): MPoC SDK2 adds potentially MPoC-relevant functions, such as message formatting or secure channel(s)

Validated through vendor testing*

Figure 4: Example Implementations using Multiple MPoC SDKs

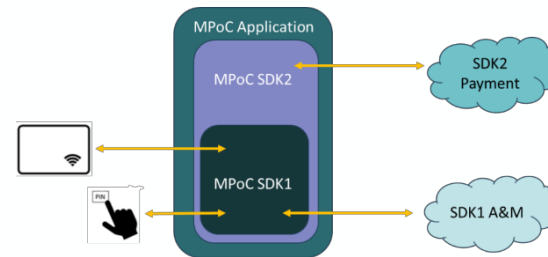

Example (3)

MPoC SDKs

Validated
through
lab testing

Depends
on change

Example (3): MPoC SDK2 adds potentially MPoC-relevant functions, such as message formatting or secure channel(s)

Figure 4: Example Implementations using Multiple MPoC SDKs

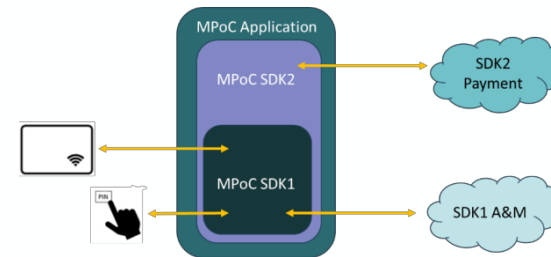

Example (3)

MPoC SDKs

Validated through lab testing

Example (1): Two separate MPoC SDKs - currently supported in MPoC v1.0.1

Example (2): MPoC SDK2 adds support for new payment channels

Depends on change

Example (3): MPoC SDK2 adds potentially MPoC-relevant functions, such as message formatting or secure channel(s)

Validated through vendor testing*

Example (4): MPoC SDK2 adds functions not relevant to MPoC, such as transport ticketing functions or rebranding

Figure 4: Example Implementations using Multiple MPoC SDKs

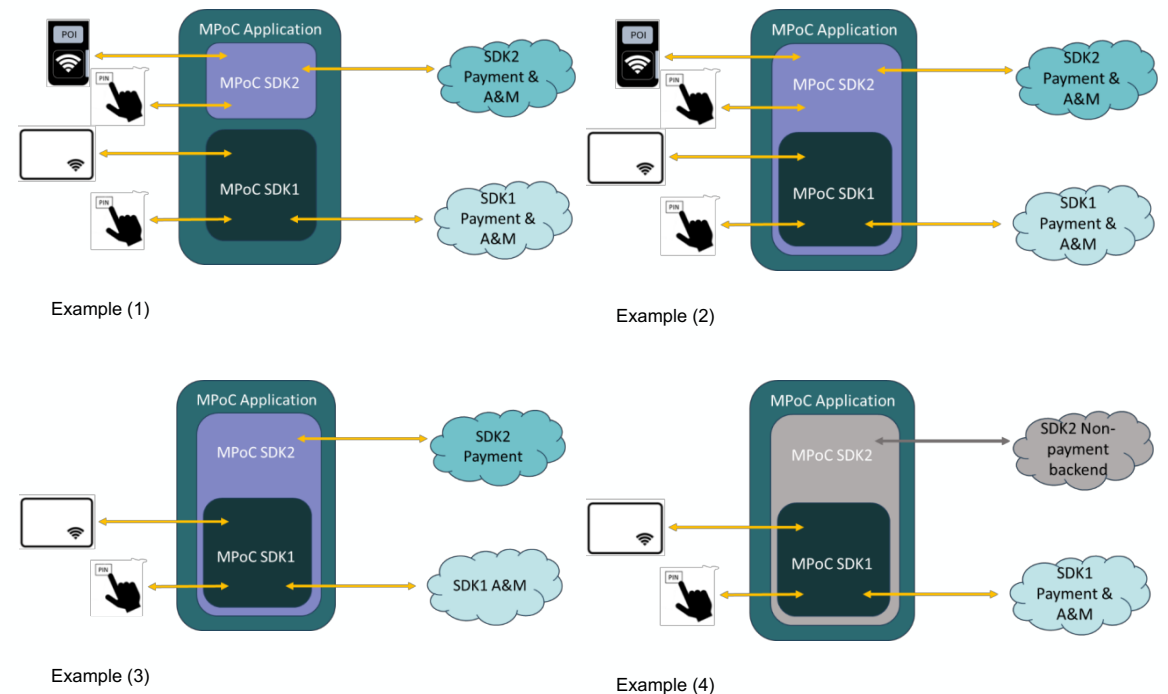

Next Steps

- MPoC v1.1 current going through the process for finalization and release
- Expect publication later this year
- Work progressing on Program aspects

MPoC is not Everything!



MPoC is not Everything!

- We're also working on an SDK module for Secure Software
- To support use cases such as:
 - Tap-to-pay on cardholder phone
 - 3DS SDK implementations



Thank You!

